



浩畅半导体
www.szhaochang.cn

MBR10150CT

10.0 AMPS. Schottky Barrier Rectifiers

产
品
规
格
书

承
认
书

客户确认：

公司签章：

部门	工程部	品保部	采购部	
签名				
日期				



MBR10150CT

10.0 AMPS. Schottky Barrier Rectifiers

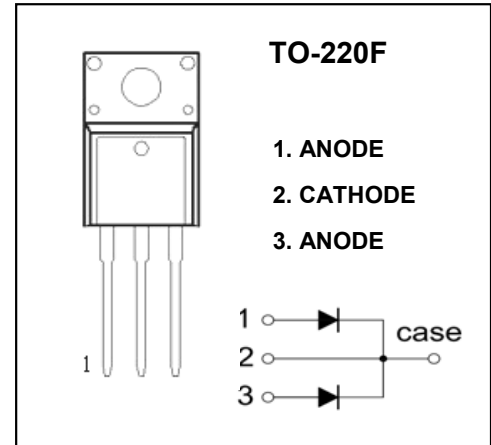
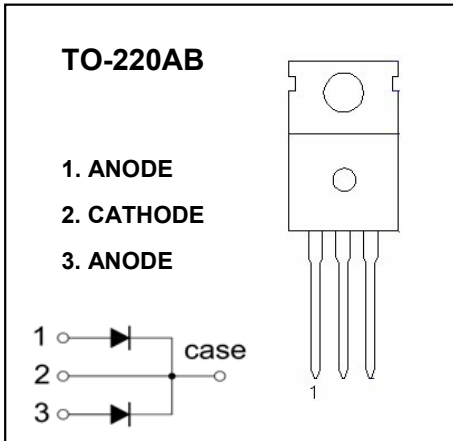

MAXIMUM RATINGS ($T_a=25^\circ\text{C}$ unless otherwise noted)

Symbol	Parameter	Value	Unit
V_{RRM}	Peak repetitive reverse voltage	150	V
V_{RWM}	Working peak reverse voltage		
V_R	DC blocking voltage		
$V_{R(RMS)}$	RMS reverse voltage	105	V
I_O	Average rectified output current	10	A
I_{FSM}	Non-Repetitive peak forward surge current 8.3ms half sine wave	120	A
P_D	Power dissipation	2	W
$R_{\theta JA}$	Thermal resistance from junction to ambient	50	$^\circ\text{C}/\text{W}$
T_j	Junction temperature	125	$^\circ\text{C}$
T_{stg}	Storage temperature	-55~+150	$^\circ\text{C}$

ELECTRICAL CHARACTERISTICS ($T_a=25^\circ\text{C}$ unless otherwise specified)

Parameter	Symbol	Test conditions	Min	Typ	Max	Unit
Reverse voltage	$V_{(BR)}$	$I_R=0.1\text{mA}$	150			V
Reverse current	I_R	$V_R=150\text{V}$			0.1	mA
Forward voltage	V_{F1}	$I_F=5\text{A}$			1	V
	V_{F2}^*	$I_F=10\text{A}$			1	V
Typical total capacitance	C_{tot}	$V_R=5\text{V}, f=1\text{MHz}$		500		pF

MBR1030CT-MBR10200CT

FIG.1- FORWARD CURRENT DERATING CURVE

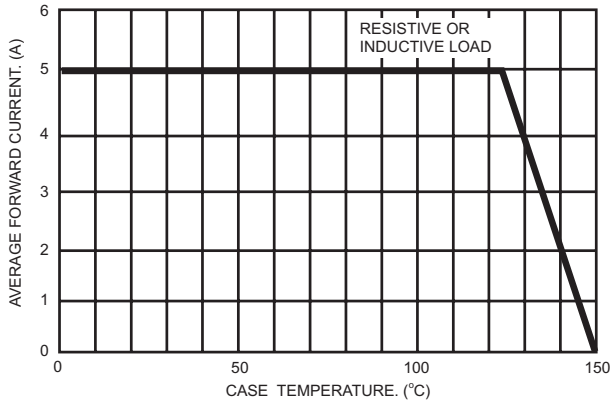

FIG.2- MAXIMUM NON-REPETITIVE FORWARD SURGE CURRENT

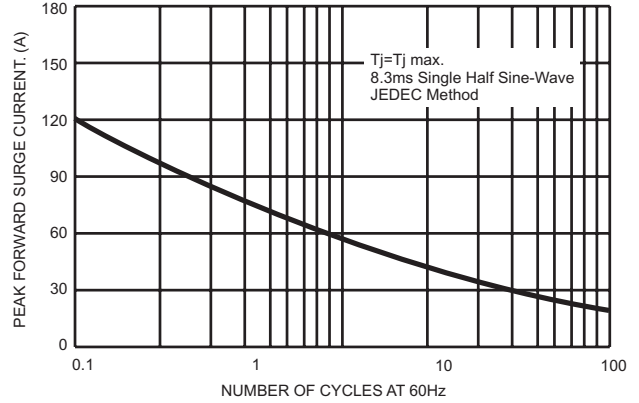

FIG.3- TYPICAL INSTANTANEOUS FORWARD CHARACTERISTICS

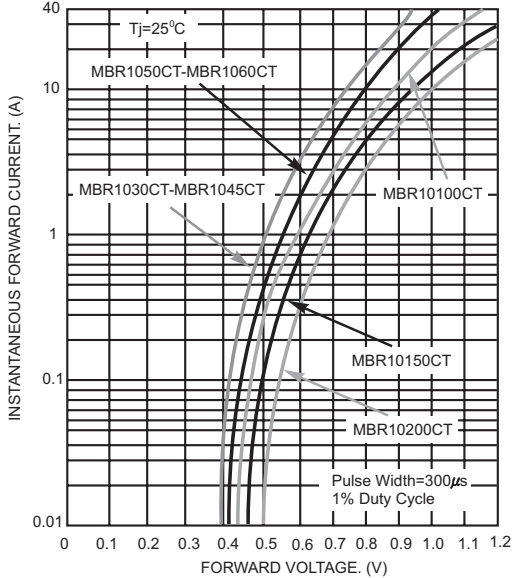

FIG.4- TYPICAL REVERSE CHARACTERISTICS

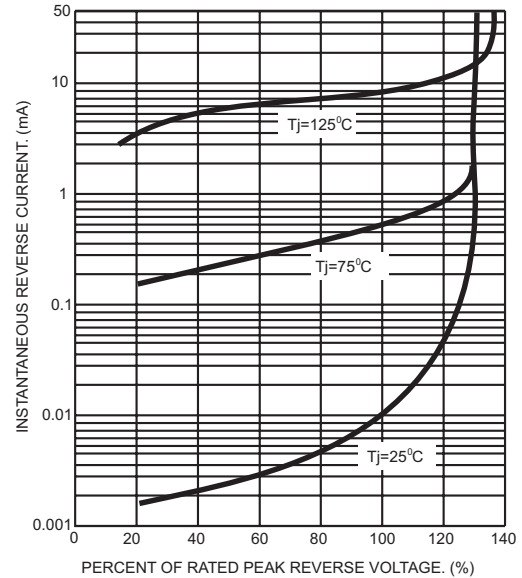

FIG.5- TYPICAL JUNCTION CAPACITANCE

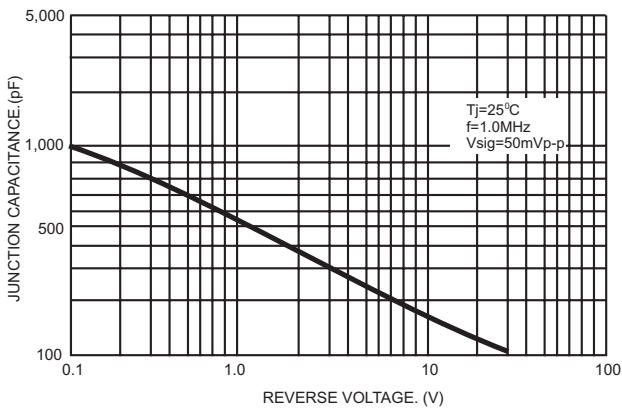

FIG.6- TYPICAL TRANSIENT THERMAL CHARACTERISTICS PER LEG

