



**TO-220 Plastic-Encapsulate Voltage Regulator**

**L7812** Three-terminal positive voltage regulator

**FEATURES**

- Maximum Output current  $I_{OM}$ : 1.5 A
- Output voltage  $V_o$ : 12 V
- Continuous total dissipation
  - $P_D$ : 1.5 W ( $T_a = 25^\circ\text{C}$ )
  - 15 W ( $T_c = 25^\circ\text{C}$ )

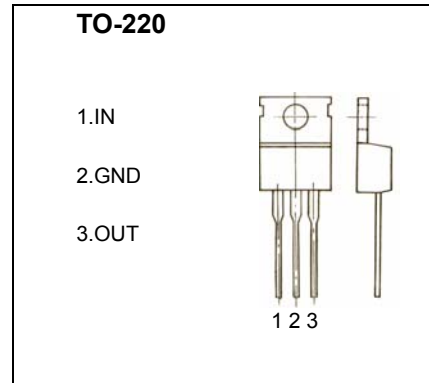

**ABSOLUTE MAXIMUM RATINGS (Operating temperature range applies unless otherwise specified)**

Parameter	Symbol	Value	Unit
Input Voltage	$V_i$	35	V
Thermal resistance junction-air	$R_{\theta JA}$	65	$^\circ\text{C}/\text{W}$
Thermal resistance junction-cases	$R_{\theta JC}$	5	$^\circ\text{C}/\text{W}$
Operating Junction Temperature Range	$T_{OPR}$	0-125	$^\circ\text{C}$
Storage Temperature Range	$T_{STG}$	-65-150	$^\circ\text{C}$

**ELECTRICAL CHARACTERISTICS AT SPECIFIED VIRTUAL JUNCTION TEMPERATURE ( $V_i=19\text{V}$ ,  $I_o=500\text{mA}$ ,  $C_i=0.33\mu\text{F}$ ,  $C_o=0.1\mu\text{F}$ , unless otherwise specified)**

Parameter	Symbol	Test conditions	MIN	TYP	MAX	UNIT
Output voltage	$V_o$	$25^\circ\text{C}$	11.5	12.0	12.5	V
		$I_o=5.0\text{mA}-1.0\text{A}$ , $P \leq 15\text{W}$ $14.5\text{V} \leq V_i \leq 27\text{V}$	0-125 $^\circ\text{C}$	11.4	12	12.6
Load Regulation	$\Delta V_o$	$14.5\text{V} \leq V_i \leq 30\text{V}$	$25^\circ\text{C}$	10	240	mV
		$16\text{V} \leq V_i \leq 22\text{V}$	$25^\circ\text{C}$	3	120	mV
Line regulation	$\Delta V_o$	$I_o=5\text{mA} - 1.5\text{A}$	$25^\circ\text{C}$	12	240	mV
		$I_o=250\text{mA} - 750\text{mA}$	$25^\circ\text{C}$	4	120	mV
Quiescent Current	$I_q$	$25^\circ\text{C}$		4.3	8	mA
Quiescent Current Change	$\Delta I_q$	$5.0\text{mA} \leq I_o \leq 1.0\text{A}$	0-125 $^\circ\text{C}$		0.5	mA
		$14.5\text{V} \leq V_i \leq 30\text{V}$	0-125 $^\circ\text{C}$		1.0	mA
Output voltage drift	$\Delta V_o / \Delta T$	$I_o=5\text{mA}$	0-125 $^\circ\text{C}$	-1		mV/ $^\circ\text{C}$
Output Noise Voltage	$V_N$	$f=10\text{Hz}$ to 100KHz	$25^\circ\text{C}$	75		$\mu\text{V}$
Ripple Rejection	RR	$f=120\text{Hz}$ , $15\text{V} \leq V_i \leq 25\text{V}$	0-125 $^\circ\text{C}$	55	71	dB
Dropout Voltage	$V_d$	$I_o=1.0\text{A}$	$25^\circ\text{C}$	2		V
Output resistance	$R_o$	$f=1\text{KHz}$	$25^\circ\text{C}$	18		m $\Omega$
Short Circuit Current	$I_{sc}$	$25^\circ\text{C}$		350		mA
Peak Current	$I_{pk}$	$25^\circ\text{C}$		2.2		A

**TYPICAL APPLICATION**

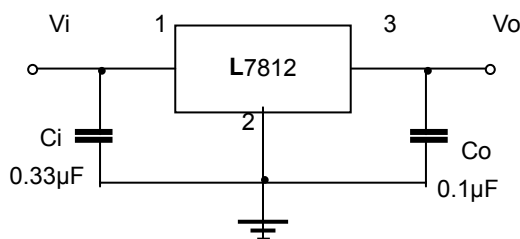

# Typical Characteristics

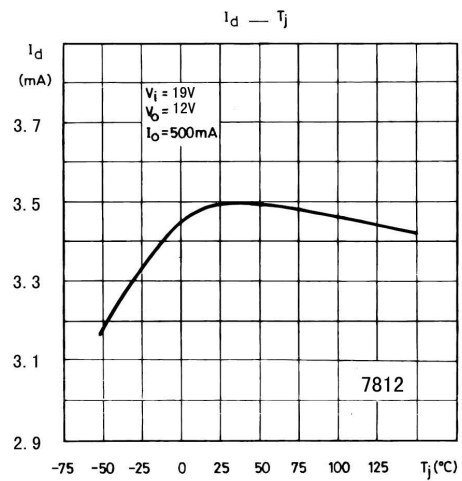
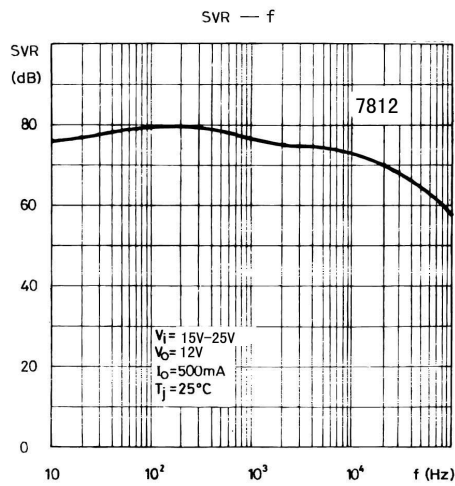
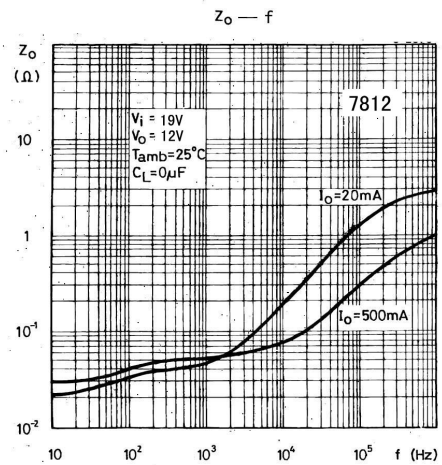
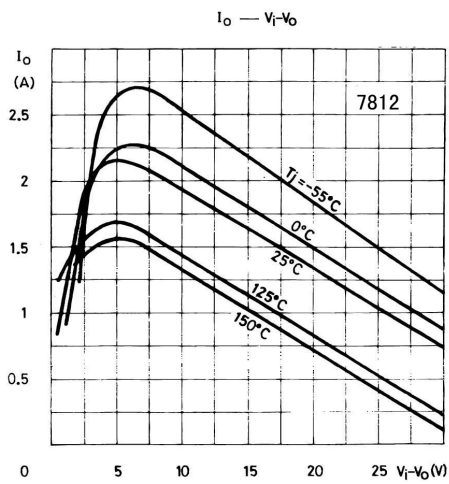
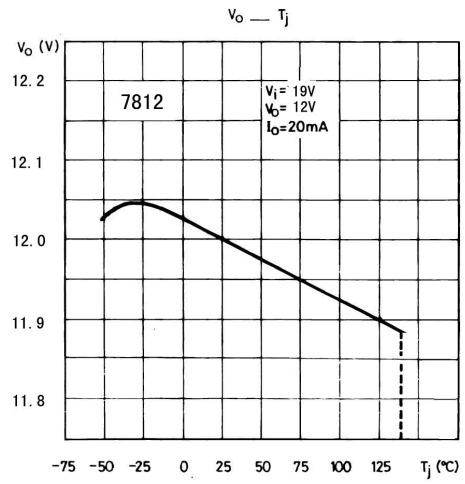
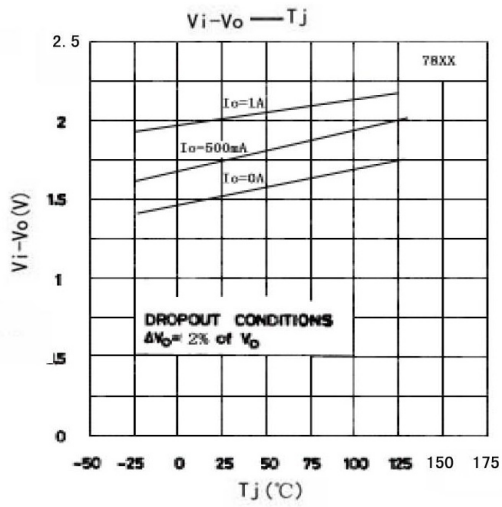

# TO-220-3L Package Outline Dimensions

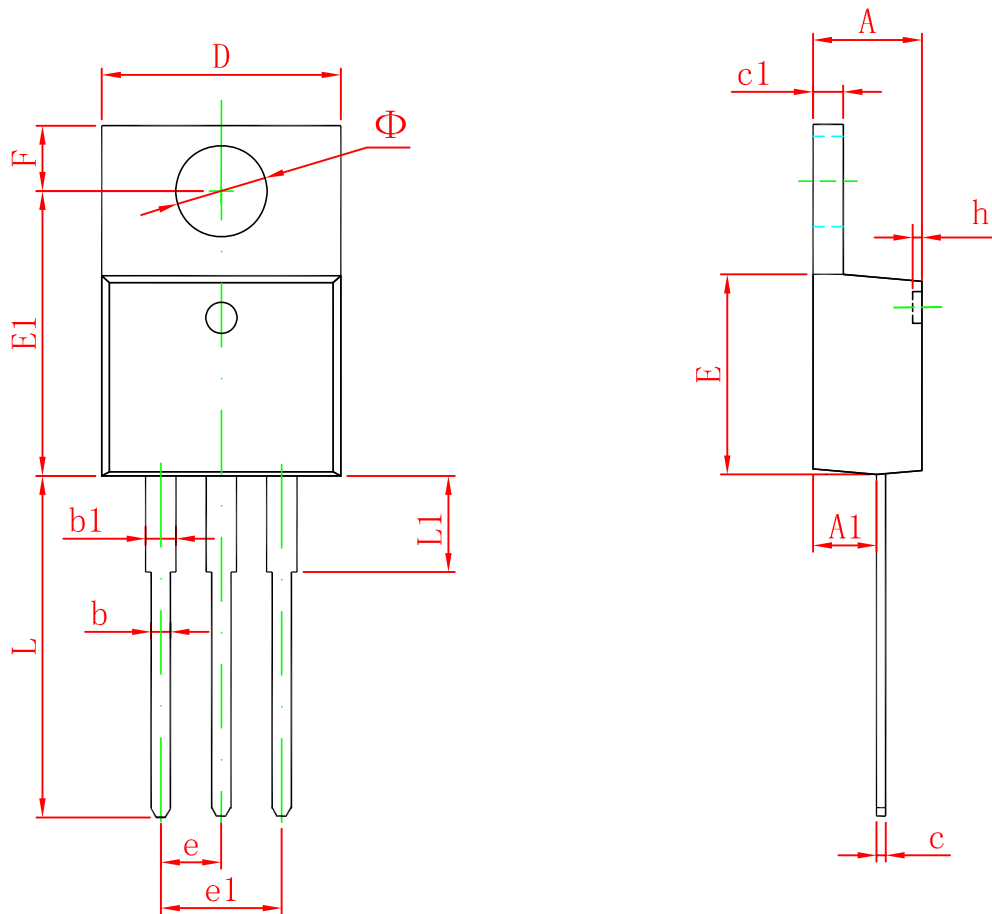

Symbol	Dimensions In Millimeters		Dimensions In Inches	
	Min	Max	Min	Max
A	4.470	4.670	0.176	0.184
A1	2.520	2.820	0.099	0.111
b	0.710	0.910	0.028	0.036
b1	1.170	1.370	0.046	0.054
c	0.310	0.530	0.012	0.021
c1	1.170	1.370	0.046	0.054
D	10.010	10.310	0.394	0.406
E	8.500	8.900	0.335	0.350
E1	12.060	12.460	0.475	0.491
e	2.540 TYP		0.100 TYP	
e1	4.980	5.180	0.196	0.204
F	2.590	2.890	0.102	0.114
h	0.000	0.300	0.000	0.012
L	13.400	13.800	0.528	0.543
L1	3.560	3.960	0.140	0.156
$\Phi$	3.735	3.935	0.147	0.155