



**浩畅半导体**  
www.szhaochang.cn

MMF) '\$5 !A A : % \$75

SURFACE MOUNT TRANSIENT VOLTAGE SUPPRESSORS

产  
品  
规  
格  
书

承  
认  
书

客户确认：

公司签章：

部门	工程部	品保部	采购部
签名			
日期			



MMF) '\$5 !A A : % \$7 5

SURFACE MOUNT TRANSIENT VOLTAGE SUPPRESSORS

# 200W Surface Mount Transient Voltage Suppressors

## Features

- Peak power dissipation 200W @10 x 1000 us Pulse
- Low profile package.
- Excellent clamping capability.
- Glass passivated junction.
- Fast response time: typically less than 1ns from 0 Volts to BV min
- Typical I<sub>R</sub> less than 1uA when V<sub>BR</sub> min above 15V.
- IEC 61000-4-2 ESD 30KV(Air), 30KV(Contact)
- ESD protection of data lines in accordance with IEC 61000-4-2
- EFT protection of data lines in accordance with IEC 61000-4-4
- Halogen free and RoHS compliant
- Lead-free finish

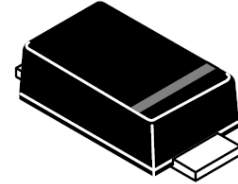

SOD-123FL

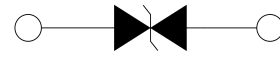

Bi-directional

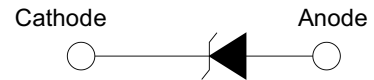

Uni-directional

## Mechanical Characteristics

- CASE: SOD-123FL Molded Plastic over glass passivated junction.
- Mounting Position: Any
- Polarity: by cathode band denotes uni-directional device, none cathode band denotes bi-directional device.
- Terminal: Solder plated

## Maximum Ratings and Characteristics @ 25°C Ambient Temperature (unless otherwise noted)

Parameter	Symbol	Value	Units
Peak Pulse Power Dissipation on 10/1000 us Waveform (Note 1, 2, FIG.1)	P <sub>PPM</sub>	Min 200	W
Peak Pulse Current of on 10/1000us Waveform (Note 1, FIG.3)	I <sub>PPM</sub>	See Table 1	A
Operating Junction Temperature Range	T <sub>J</sub>	-55 to 150	°C
Storage Temperature Range	T <sub>STG</sub>	-55 to 150	°C

Notes:

1. Non-repetitive current pulse, per Fig.3 and derated above T<sub>A</sub>=25°C per Fig.2.

# MMF) '\$5!A A : % \$75

## Electrical Specification @ Tamb 25°C

Type Number		Marking		Reverse	Breakdown Voltage Min. @I <sub>T</sub>	Breakdown Voltage Max. @ I <sub>T</sub>	Test Current	Maximum Clamping Voltage @I <sub>PP</sub>	Peak Pulse Current	Reverse Leakage @V <sub>RMW</sub>
Uni	Bi	Uni	Bi	V <sub>RMW</sub> (V)	V <sub>BR MIN</sub> (V)	V <sub>BR MAX</sub> (V)	I <sub>T</sub> (mA)	V <sub>C</sub> (V)	I <sub>PP</sub> (A)	I <sub>R</sub> (uA)
MMF5.0A	MMF5.0CA	5.0A	5.0CA	5.0	6.40	7.00	10	9.2	21.7	400.0
MMF6.0A	MMF6.0CA	6.0A	6.0CA	6.0	6.67	7.37	10	10.3	19.4	400.0
MMF6.5A	MMF6.5CA	6.5A	6.5CA	6.5	7.22	7.98	10	11.2	17.9	250.0
MMF7.0A	MMF7.0CA	7.0A	7.0CA	7.0	7.78	8.60	10	12.0	16.7	100.0
MMF7.5A	MMF7.5CA	7.5A	7.5CA	7.5	8.33	9.21	1	12.9	15.5	50.0
MMF8.0A	MMF8.0CA	8.0A	8.0CA	8.0	8.89	9.83	1	13.6	14.7	25.0
MMF8.5A	MMF8.5CA	8.5A	8.5CA	8.5	9.44	10.40	1	14.4	13.9	10.0
MMF9.0A	MMF9.0CA	9.0A	9.0CA	9.0	10.00	11.10	1	15.4	13.0	5.0
MMF10A	MMF10CA	10A	10CA	10.0	11.10	12.30	1	17.0	11.8	2.5
MMF11A	MMF11CA	11A	11CA	11.0	12.20	13.50	1	18.2	11.0	2.5
MMF12A	MMF12CA	12A	12CA	12.0	13.30	14.70	1	19.9	10.1	2.5
MMF13A	MMF13CA	13A	13CA	13.0	14.40	15.90	1	21.5	9.3	1
MMF14A	MMF14CA	14A	14CA	14.0	15.60	17.20	1	23.2	8.6	1
MMF15A	MMF15CA	15A	15CA	15.0	16.70	18.50	1	24.4	8.2	1
MMF16A	MMF16CA	16A	16CA	16.0	17.80	19.70	1	26.0	7.7	1
MMF17A	MMF17CA	17A	17CA	17.0	18.90	20.90	1	27.6	7.2	1
MMF18A	MMF18CA	18A	18CA	18.0	20.00	22.10	1	29.2	6.8	1
MMF20A	MMF20CA	20A	20CA	20.0	22.20	24.50	1	32.4	6.2	1
MMF22A	MMF22CA	22A	22CA	22.0	24.40	26.90	1	35.5	5.6	1
MMF24A	MMF24CA	24A	24CA	24.0	26.70	29.50	1	38.9	5.1	1
MMF26A	MMF26CA	26A	26CA	26.0	28.90	31.90	1	42.1	4.8	1
MMF28A	MMF28CA	28A	28CA	28.0	31.10	34.40	1	45.4	4.4	1
MMF30A	MMF30CA	30A	30CA	30.0	33.30	36.80	1	48.4	4.1	1
MMF33A	MMF33CA	33A	33CA	33.0	36.70	40.60	1	53.3	3.8	1
MMF36A	MMF36CA	36A	36CA	36.0	40.00	44.20	1	58.1	3.4	1
MMF40A	MMF40CA	40A	40CA	40.0	44.40	49.10	1	64.5	3.1	1
MMF43A	MMF43CA	43A	43CA	43.0	47.80	52.80	1	69.4	2.9	1
MMF45A	MMF45CA	45A	45CA	45.0	50.00	55.30	1	72.7	2.8	1
MMF48A	MMF48CA	48A	48CA	48.0	53.30	58.90	1	77.4	2.6	1
MMF51A	MMF51CA	51A	51CA	51.0	56.70	62.70	1	82.4	2.4	1
MMF54A	MMF54CA	54A	54CA	54.0	60.00	66.30	1	87.1	2.3	1
MMF58A	MMF58CA	58A	58CA	58.0	64.40	71.20	1	93.6	2.1	1
MMF60A	MMF60CA	60A	60CA	60.0	66.70	73.70	1	96.8	1.8	1
MMF64A	MMF64CA	64A	64CA	64.0	71.10	78.60	1	103.0	1.7	1
MMF70A	MMF70CA	70A	70CA	70.0	77.80	86.00	1	113.0	1.5	1
MMF75A	MMF75CA	75A	75CA	75.0	83.30	92.10	1	121.0	1.4	1

※ For Bi-directional type having V<sub>RMW</sub> of 10 Volts and less, the I<sub>R</sub> limit is double

# MMF) '\$5!AA : % \$75

Type Number		Marking		Reverse Stand-Off Voltage	Breakdown Voltage Min. @ $I_T$	Breakdown Voltage Max. @ $I_T$	Test Current	Maximum Clamping Voltage @ $I_{PP}$	Peak Pulse Current	Reverse Leakage @ $V_{RWM}$
Uni	Bi	Uni	Bi	$V_{RWM}(V)$	$V_{BR MIN}(V)$	$V_{BR MAX}(V)$	$I_T (mA)$	$V_C(V)$	$I_{PP}(A)$	$I_R(\mu A)$
MMF78A	MMF78CA	78A	78CA	78.0	86.70	95.80	1	126.0	1.4	1
MMF85A	MMF85CA	85A	85CA	85.0	94.40	104.00	1	137.0	1.3	1
MMF90A	MMF90CA	90A	90CA	90.0	100.00	111.00	1	146.0	1.2	1
MMF100A	MMF100CA	100	100C	100.0	111.00	123.00	1	162.0	1.1	1
MMF110A	MMF110CA	110	110C	110.0	122.00	135.00	1	177.0	1.0	1
MMF120A	MMF120CA	120	120C	120.0	133.00	147.00	1	193.0	0.9	1
MMF130A	MMF130CA	130	130C	130.0	144.00	159.00	1	209.0	0.8	1
MMF150A	MMF150CA	150	150C	150.0	167.00	185.00	1	243.0	0.7	1
MMF160A	MMF160CA	160	160C	160.0	178.00	197.00	1	259.0	0.7	1
MMF170A	MMF170CA	170	170C	170.0	189.00	209.00	1	275.0	0.6	1
MMF180A	MMF180CA	180	180C	180.0	198.00	222.00	1	292.0	0.6	1
MMF190A	MMF190CA	190	190C	190.0	209.00	233.00	1	308.0	0.5	1

※ For Bi-directional type having  $V_{RWM}$  of 10 Volts and less, the  $I_R$  limit is double

## I-V Curve Characteristics

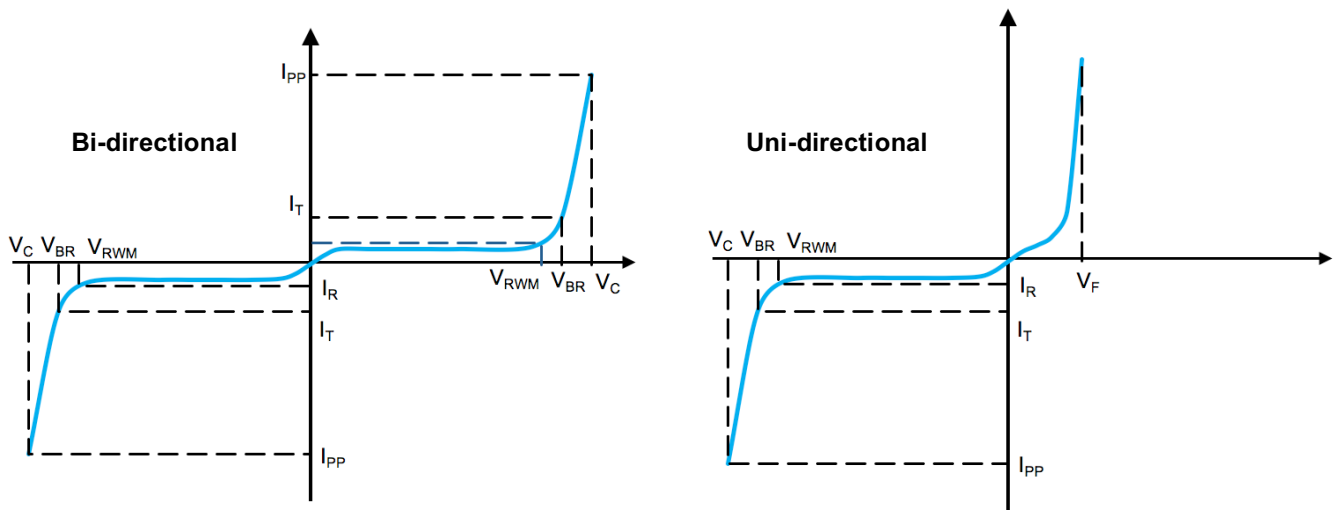

**$I_{PPM}$**  Peak Pulse Power Dissipation - Max power dissipation

**$V_{RWM}$**  Reverse Stand-off Voltage - Maximum voltage that can be applied to TVS without operation

**$V_{BR}$**  Breakdown Voltage – Maximum voltage that flows through the TVS at a specified current ( $I_T$ )

**$V_C$**  Clamping Voltage – Peak voltage measured across the TVS at a specified  $I_{PPM}$  (peak impulse current)

**$I_R$**  Reverse Leakage Current – Current measured at  $V_R$

**$V_F$**  Forward Voltage Drop for Uni-directional

**Ratings and Characteristic Curves** ( $T_A=25^\circ\text{C}$  unless otherwise noted)

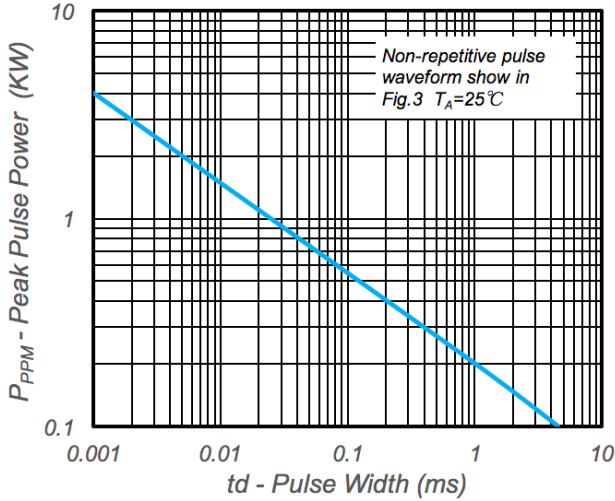

Fig.1 Peak Pulse Power Rating

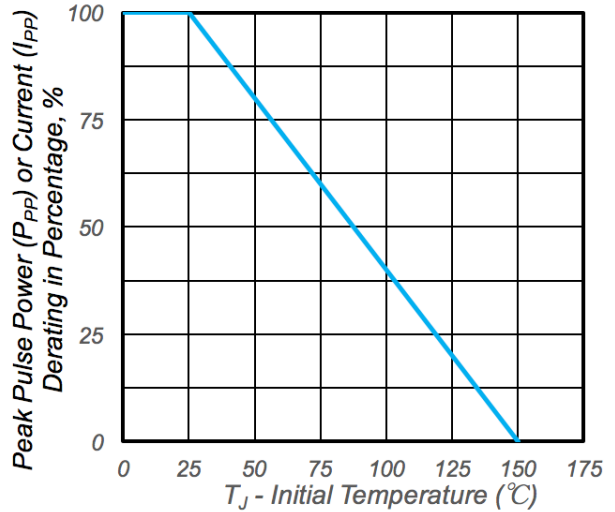

Fig.2 Pulse Derating Curve

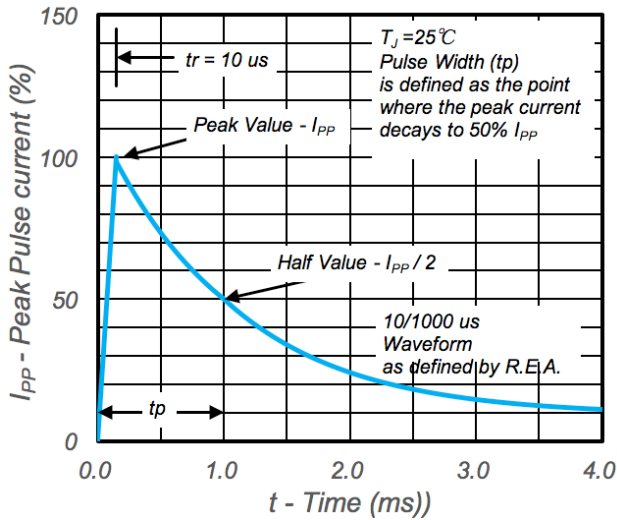

Fig.3 Pulse Waveform

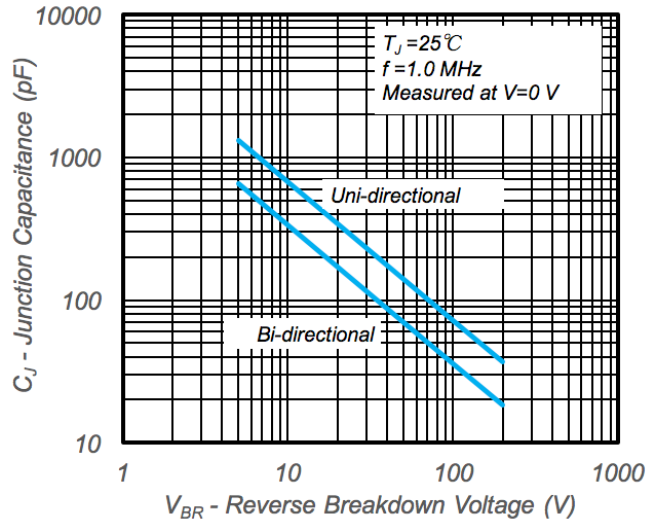
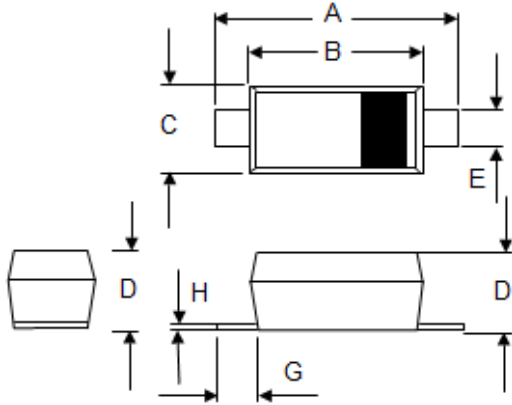

Fig.4 Typical Junction Capacitance

**Package Outline Dimensions and Pad Layouts**

**SOD-123FL**



Dim	Millimeters		Inches	
	Min	Max	Min	Max
A	3.40	3.95	0.142	0.155
B	2.50	2.90	0.098	0.114
C	1.40	1.95	0.055	0.077
D	0.90	1.35	0.035	0.053
E	0.50	1.10	0.020	0.043
G	0.25	-----	0.010	----
H	-----	0.20	----	0.008